

<b>Bike</b>	Triumph Street Triple 765 R / RS	<b>Part No.</b>	PTR-89
<b>Year</b>	2020-2022	<b>Fit Kit</b>	Z039.10684
<b>Notes</b>	Where not supplied use original fittings	<b>dB Killer</b>	SCEXDBK48 - (Type PC)

Estimated Fitting Time: 60 Minutes

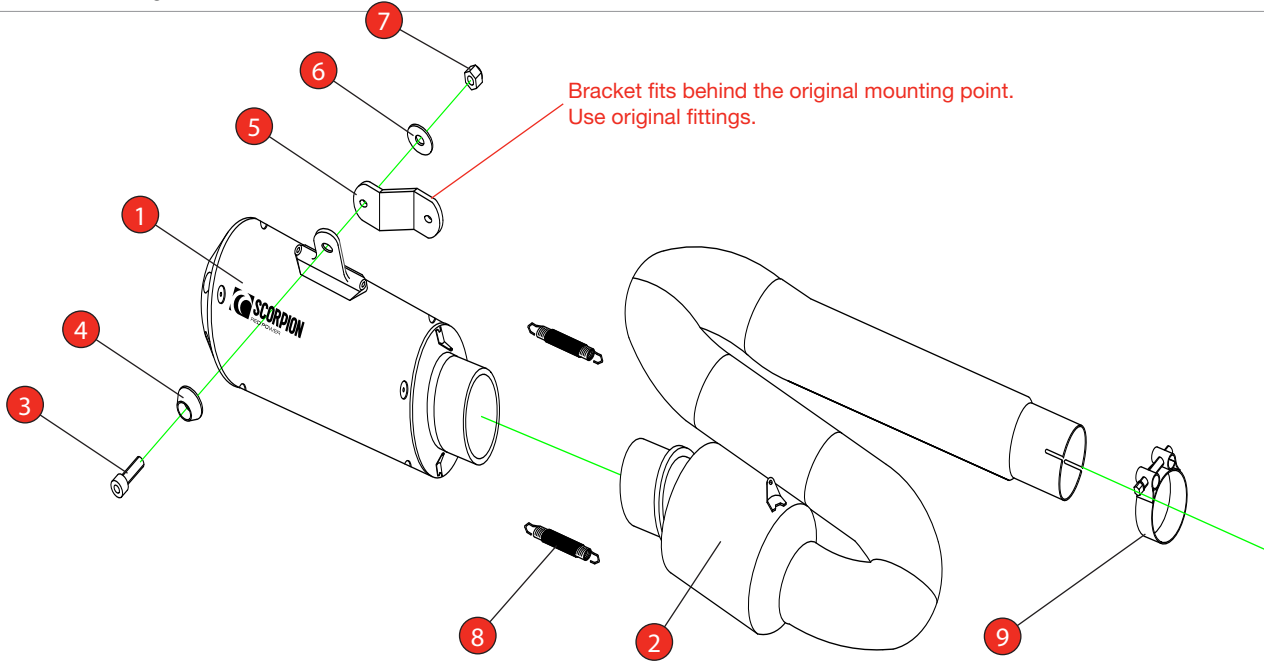

NO.	PART NO.	DESCRIPTION	QTY
1	PSC492	Red Power Silencer	1
2	CP954	Connecting Pipe	1
<b>Fit Kit - Z039.10684</b>			
3	Z017.10073	M8 x 25mm Cap Head Bolt	1
4	Z026.20068	Alloy Bolt Finisher	1
5	Z015.31419	Mounting Bracket	1
6	Z017.10825	M8 x 25mm Washer	1
7	Z017.10062	M8 Nyloc Nut	1
8	Z028.10030	Rubber Coated Spring	2
9	Z016.10008	43-47mm Clamp	1

CLASSIFICATION	Closed Circuit Product
HOMOLOGATED	No
DATE	09/05/2023
ISSUE	03
AUTHORISED	S Shipley

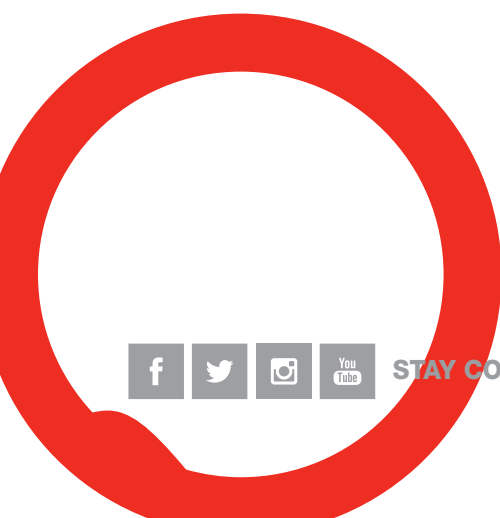

STAY CONNECTED TO RED POWER.

<b>Bike</b>	Triumph Street Triple 765 R / RS	<b>Part No.</b>	PTR-89
<b>Year</b>	2020-2022	<b>Fit Kit</b>	Z039.10684
<b>Notes</b>	Where not supplied use original fittings	<b>dB Killer</b>	SCEXDBK48 - (Type PC)

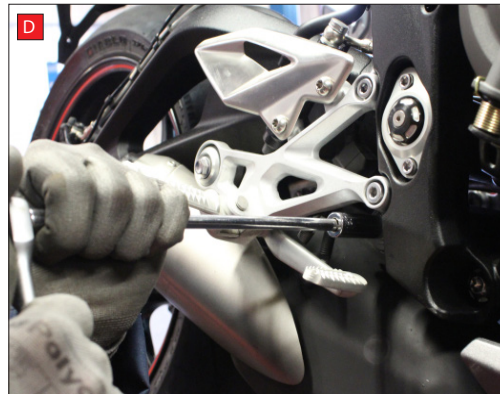

Note: Retain all original parts and fittings. Instructions show a Serket taper silencer, instructions are the same when fitting an Red Power .

A) Unscrew heat shield bolt and remove heat shield.

B) Undo original clamp and remove it from the bike.

C) Unscrew the original silencer mounting bolt.

D) Unscrew the second original silencer mounting bolt.

E) Remove the silencer from the bike.

F/G) Some bikes have a collar that the rear silencer butts up to. If your bike has this you will need to remove it to allow the Scorpion system to slide all the way on to the pipe.

H) Following the diagram above, loosely fit the Scorpion system.



<b>Bike</b>	Triumph Street Triple 765 R / RS	<b>Part No.</b>	PTR-89
<b>Year</b>	2020-2022	<b>Fit Kit</b>	Z039.10684
<b>Notes</b>	Where not supplied use original fittings	<b>dB Killer</b>	SCEXDBK48 - (Type PC)

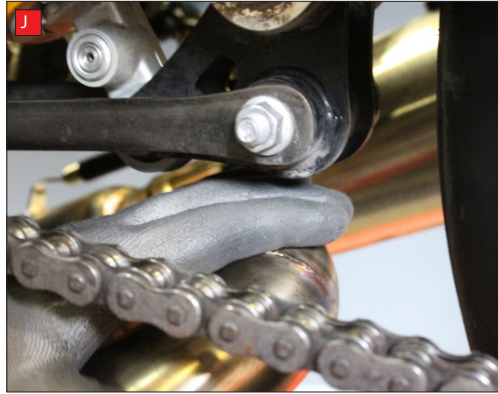
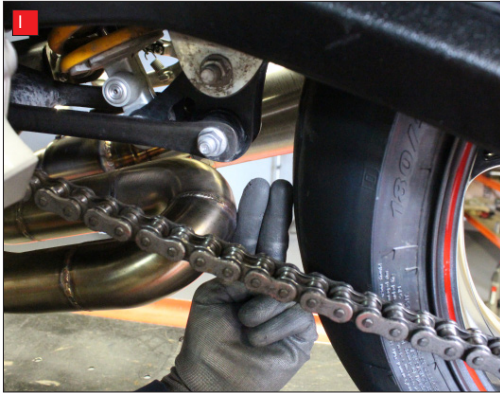

I) Check the clearance between the pipework and the rear tyre, this requires a minimum spacing 45mm.

J) Check the clearance between the pipework and the suspension linkage, this requires a spacing of at least 20mm.

K) Looking from the rear of the bike ensure the silencer does not protrude past the foot peg.

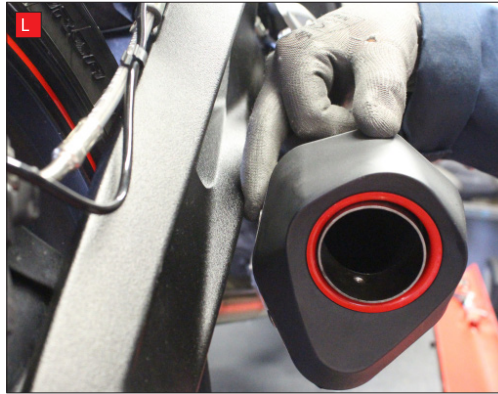
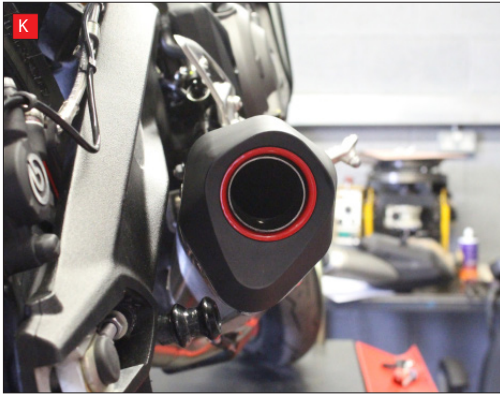

L) Check the clearance between the silencer and the swing arm, this requires a minimum spacing of 15mm.

M) Check the clearance of between the silencer and brake lever. Press brake lever down to ensure it does not touch the silencer at any point during use.

N) Once happy with the alignment of your exhaust, tighten all fittings. Take bike for a short ride. Upon return allow the system to cool and check all

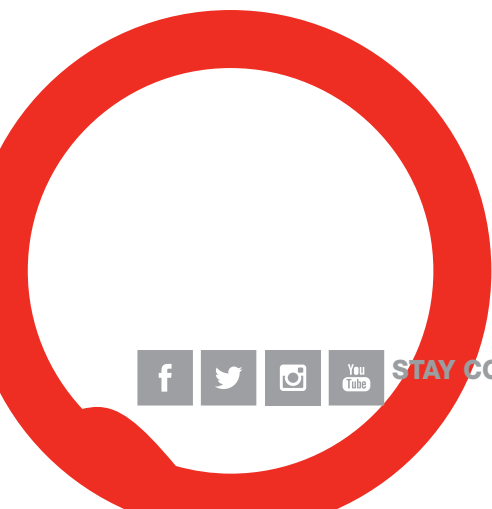
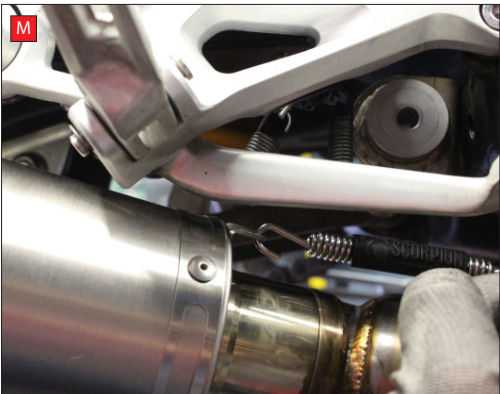

<b>Bike</b>	Triumph Street Triple 765 R / RS	<b>Part No.</b>	PTR-89
<b>Year</b>	2020-2022	<b>Fit Kit</b>	Z039.10684
<b>Notes</b>	Where not supplied use original fittings	<b>dB Killer</b>	SCEXDBK48 - (Type PC)

Estimated Fitting Time: 60 Minutes



Thank you for purchasing your Scorpion Silencer.

Care of your exhaust: Please refrain from cleaning silencer with heavy solvents or abrasives!

Vielen Dank Für den kauf eines Scorpion Schalldampfers! Pflegehinweis: Bitte verwenden Sie niemals Scheuermittel oder aggressive Reiniger zur Pflege Ihres Auspuffes!

Merci d'avoir choisi un echappement Scorpion.

Entretien de votre silencieux: Ne pas utiliser de solvants ou de produits abrasifs!

Muchas gracias por adquirir un Silencioso Scorpion. Le recomendamos no limpiar el silencioso con productos abrasivos o aquellos que contengan disolventes.



STAY CONNECTED TO RED POWER.