

Bike	Yamaha XSR 900	Part No.	RYA-127-SYS
Year	2022-Current	Fit Kit	Z039.10730
Notes	Where not supplied use original fittings	dB Killer	SCEXDBK24 (TYPE W)

Estimated Fitting Time: 60 Minutes

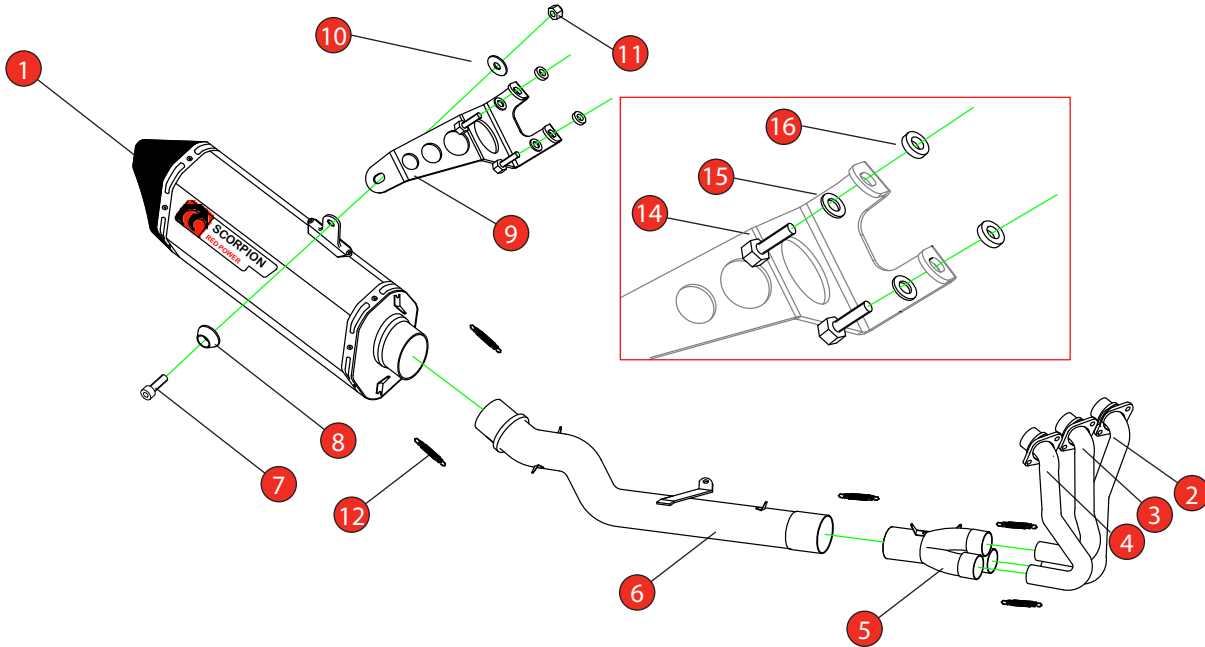

NO.	PART NO.	DESCRIPTION	QTY
1	RSC499	Serket Taper Silencer	1
2	CP1128	L/H Header Pipe	1
3	CP1129	Centre Header Pipe	1
4	CP1130	R/H Header Pipe	1
5	CP1131	Collector	1
6	CP1132	Connecting Pipe	1
Fit Kit - Z039.10730			
7	Z017.10073	M8 x 25mm Cap Head Bolt	1
8	Z026.20068B	Alloy Bolt Finisher Anodised Black	1
9	Z015.31561	Mounting Bracket	1
10	Z017.10825	M8 x 25mm Washer	1
11	Z017.10062	M8 Nyloc Nut	1
12	Z028.10030	Rubber Coated Spring	5
13	Z024.11134	Lambda Extension Cable	1
14	Z017.10044	M8 x 20mm Hex Bolt	2
15	Z017.10831	M8 x 17mm Washer	2
16	Z026.20049	M8 x 5mm Spacer	2

CLASSIFICATION	Closed Circuit Product
HOMOLOGATED	NO
DATE	10/10/2023
ISSUE	00
AUTHORISED	S Shipley

NOTE: ENSURE SCORPION SYSTEM IS CLEAR OF MOVING PARTS AND ALL ORIGINAL FUNCTIONS WORK CORRECTLY.



STAY CONNECTED TO RED POWER.

Bike	Yamaha XSR 900	Part No.	RYA-127-SYS
Year	2022-Current	Fit Kits	Z039.10730
Notes	Where not supplied use original fittings	dB Killer	SCEXDBK24 (TYPE W)

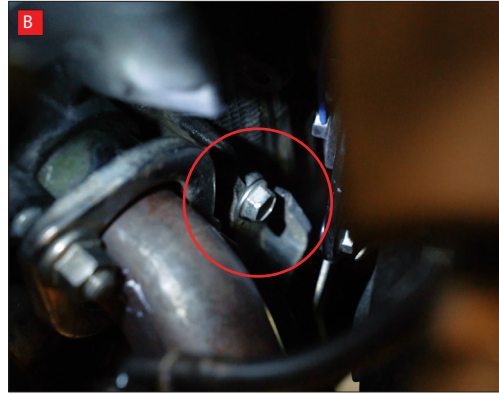

A) Remove the Lambda sensor from the original exhaust.

B) Remove the bolt from the radiator support bracket between the header pipes. This will allow you to move the radiator forward slightly to give better access to the header nuts.

C) Once the bolt is removed pull the pin from the mounting rubber

D) Remove all 6 header nuts.

E) On the left hand side of the bike remove the silencer mounting bolt.

F) On the right hand side of the bike, support the weight of the exhaust then remove the silencer mounting bolt. You can now carefully remove the exhaust from the bike.

G) Remove the metal insert and rubber bush from the left hand side of the bike. This mounting isn't used with the Scorpion system.

H) On the right hand side of the bike, behind the rear foot peg, remove the 2 circled bolts, this is where the new mounting bracket will attach.



Bike	Yamaha XSR 900	Part No.	RYA-127-SYS
Year	2022-Current	Fit Kits	Z039.10730
Notes	Where not supplied use original fittings	dB Killer	SCEXDBK24 (TYPE W)



I) Using the diagram on the 1st page, install the new mounting bracket with the supplied hardware. Leave the bolts loose to allow adjustment, you will fully tighten them in a later step.

J) Starting from the left loosely fit the scorpion header pipes. Do not fully tighten until the whole system is fitted.

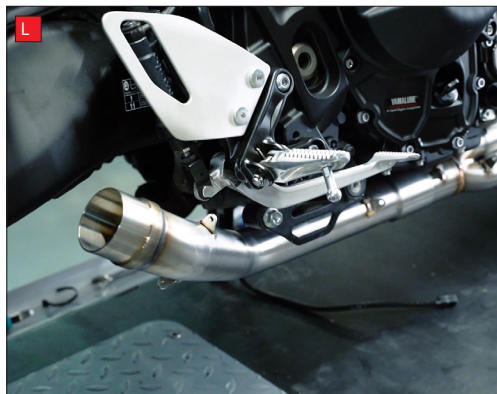

K) Insert the header pipes into the collector.

L) Fit the connecting pipe to the collector. Use the original bolt to secure the pipe to the bike.



M) Slide the silencer on to the connecting pipe.

N) Align the silencer and the mounting bracket, then secure in place using the nuts and bolts provided. Leave slightly loose for now, you will fully tighten later.

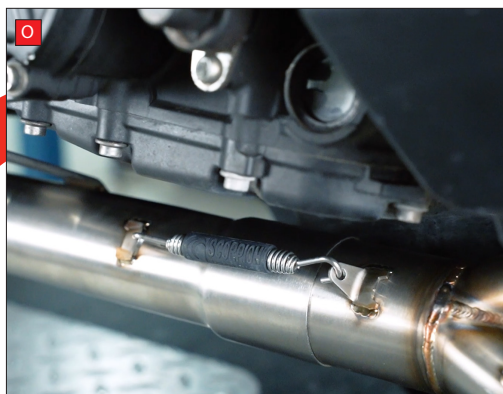

O) Install all of the supplied springs between the spring hoops.

P) Fully tighten the header nuts.

Bike	Yamaha XSR 900	Part No.	RYA-127-SYS
Year	2022-Current	Fit Kits	Z039.10730
Notes	Where not supplied use original fittings	dB Killer	SCEXDBK24 (TYPE W)

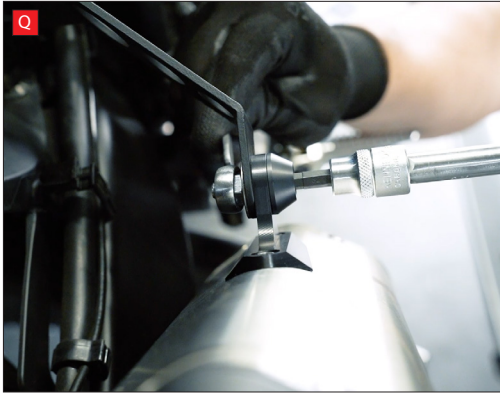

Q) Fully tighten the silencer to mounting bracket bolt.

R) Fully tighten the bolts securing the mounting bracket to the frame.

S) On the left side of the bike remove the cover from the side of the radiator.

T) Disconnect the lambda sensor cable from its plug.

U) Connect the supplied lambda extension cable to the plug.

V) Feed the end of the cable through the gap above the radiator.

W) Run the cable behind the frame and engine mounting.

X) Install the lambda sensor and fully tighten.

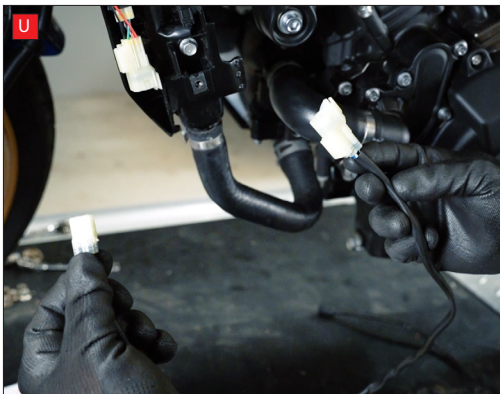
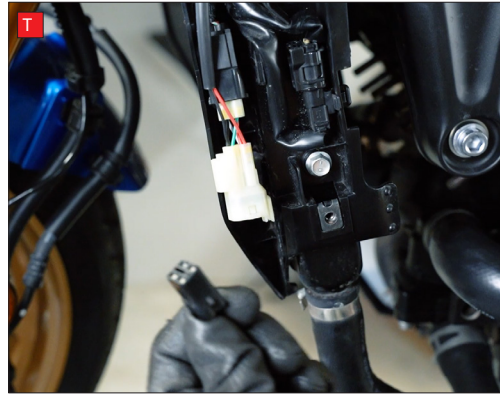

Bike	Yamaha XSR 900	Part No.	RYA-127-SYS
Year	2022-Current	Fit Kits	Z039.10730
Notes	Where not supplied use original fittings	dB Killer	SCEXDBK24 (TYPE W)



Y) Connect the lambda sensor to the extension cable and neatly secure with the breather pipes.

Z) Reinstall the side panel.

AA) Reinstall the radiator support bracket.

When fitted take bike for a short ride to ensure all functions are correct. When bike & exhaust are cool enough check all nuts and bolts are still secure.

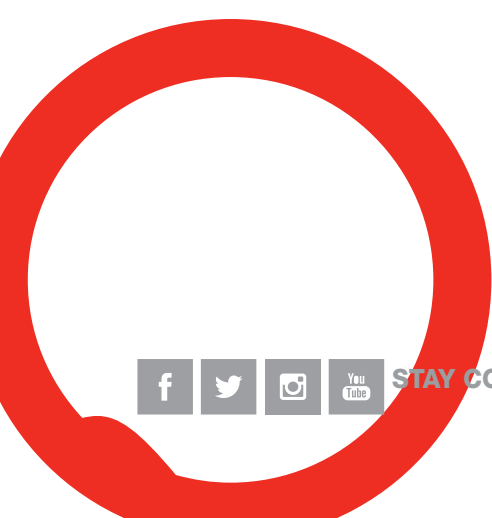

STAY CONNECTED TO RED POWER.

Bike	Yamaha XSR 900	Part No.	RYA-127-SYS
Year	2022-Current	Fit Kits	Z039.10730
Notes	Where not supplied use original fittings	dB Killer	SCEXDBK24 (TYPE W)



Thank you for purchasing your Scorpion Silencer.

Care of your exhaust: Please refrain from cleaning silencer with heavy solvents or abrasives!

Vielen Dank Für den kauf eines Scorpion Schalldampfers! Pflegehinweis: Bitte verwenden Sie niemals Scheuermittel oder aggressive Reiniger zur Pflege Ihres Auspuffes!

Merci d'avoir choisi un echappement Scorpion.

Entretien de votre silencieux: Ne pas utiliser de solvants ou de produits abrasifs!

Muchas gracias por adquirir un Silencioso Scorpion. Le recomendamos no limpiar el silencioso con productos abrasivos o aquellos que contengan disolventes.



STAY CONNECTED TO RED POWER.