

Bike	Triumph Tiger Sport 660	Part No.	RTR-93-SYS
Year	2022-Current	Fit Kit	Z039.10697
Notes	Where not supplied use original fittings If header gaskets need replacing use Triumph part number T2200854	dB Killer	SCEXDBK23 (TYPE V)

Estimated Fitting Time: 60 Minutes

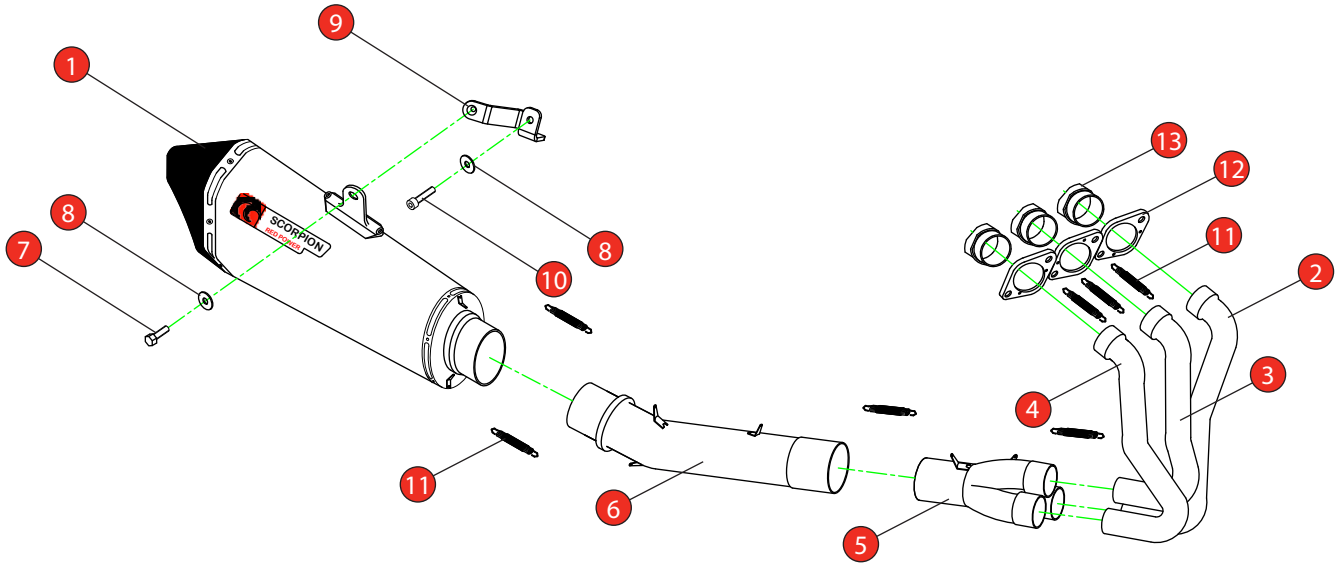

NO.	PART NO.	DESCRIPTION	QTY
1	RSC231	Serket Taper Silencer	1
2	CP1122	L/H Header Pipe	1
3	CP1123	Centre Header Pipe	1
4	CP1124	R/H Header Pipe	1
5	CP1125	Collector	1
6	CP1126	Connecting Pipe	1
Fit Kit - Z039.10697			
7	Z017.10047	M8 x 25mm Hex Head Bolt	1
8	Z017.10825	M8 x 25mm Washer	2
9	Z015.31434	Mounting Bracket	1
10	Z017.10075	M8 x 35mm Cap Head Bolt	1
11	Z028.10030	Rubber Coated Spring	7
12	Z007.31692	Header Flange	3
13	Z026.20336	Header Collar	3

CLASSIFICATION	Closed Circuit Product
HOMOLOGATED	No
DATE	31/10/2022
ISSUE	00
AUTHORISED	S Shipley

NOTE: ENSURE SCORPION SYSTEM IS CLEAR OF MOVING PARTS AND ALL ORIGINAL FUNCTIONS WORK CORRECTLY.

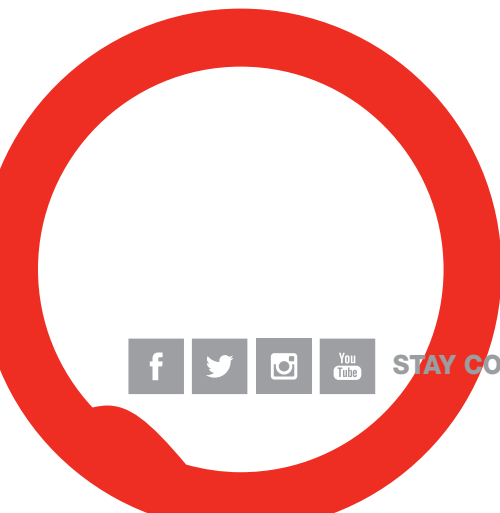

STAY CONNECTED TO RED POWER.

Bike	Triumph Tiger Sport 660	Part No.	RTR-93-SYS
Year	2022-Current	Fit Kits	Z039.10697
Notes	Where not supplied use original fittings If header gaskets need replacing use Triumph part number T2200854	dB Killer	SCEXDBK23 (TYPE V)

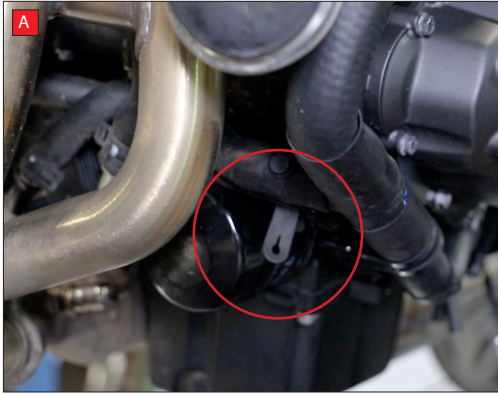

A) On the left side of the bike unclip the rubber cable tie and then disconnect the lambda sensor.

B) Remove the lambda sensor.

C) On the right side of the bike remove the screw from the side panel.

D) Carefully pull the panel from the bottom to unclip it and then remove it from the bike.



E) Repeat steps C and D on the left side of the bike.

F) Loosen the radiator upper mounting bolt. Do NOT remove completely.

G) On the right side of the bike remove the 2 side panel mounting screws and remove the panel from the bike.

H) Now remove the radiator mounting screws.

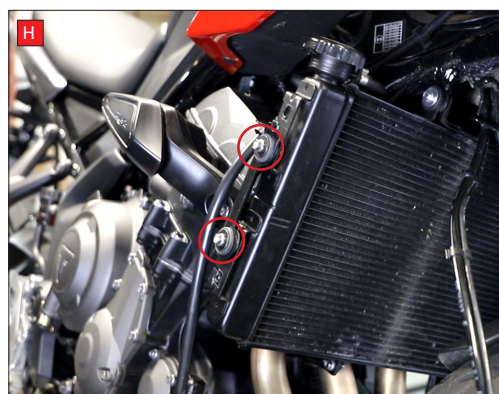

Bike	Triumph Tiger Sport 660	Part No.	RTR-93-SYS
Year	2022-Current	Fit Kits	Z039.10697
Notes	Where not supplied use original fittings If header gaskets need replacing use Triumph part number T2200854	dB Killer	SCEXDBK23 (TYPE V)



I) On the left side of the bike remove the 2 side panel mounting screws

J) Unplug the horn, then remove the side panel.

K) Remove the 2 radiator mounting screws.

L) Remove the 2 screws from the radiator lower mounting bracket and remove the bracket from the bike. The radiator will now be free to move giving you a little more space to access the header nuts.

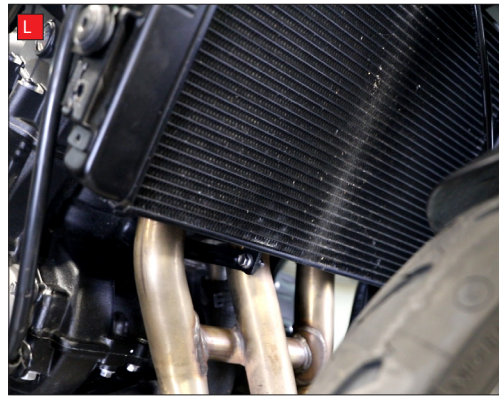

M) Remove all 6 header nuts.

N) On the left side of the bike remove the 2 foot rest mounting bolts and remove the foot rest from the bike. This will give you access to the silencer mounting bolt behind it.

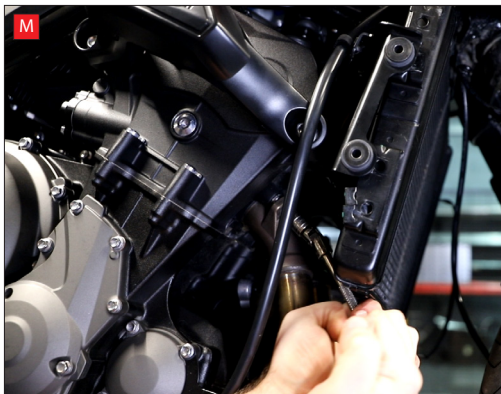

O) Remove the silencer mounting bolt.

P) On the right side of the bike remove the 2 foot rest / brake lever mounting bolts and move to one side to get access to the silencer mounting bolt.

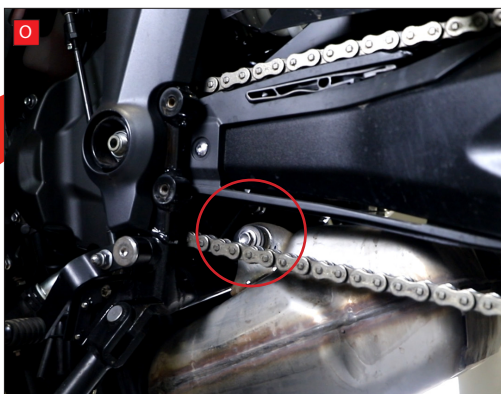

Bike	Triumph Tiger Sport 660	Part No.	RTR-93-SYS
Year	2022-Current	Fit Kits	Z039.10697
Notes	Where not supplied use original fittings If header gaskets need replacing use Triumph part number T2200854	dB Killer	SCEXDBK23 (TYPE V)

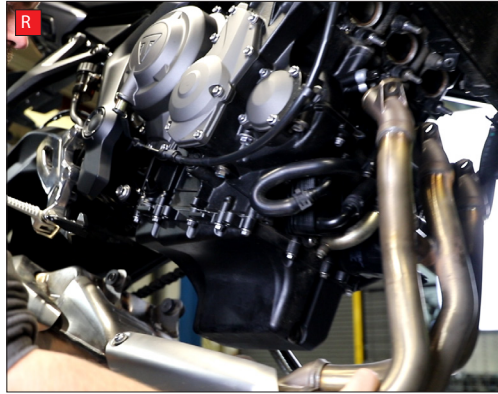
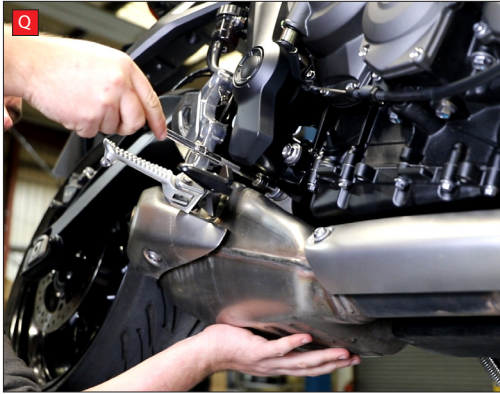

Q) Support the silencer from underneath, then remove the silencer mounting bolt.

R) Carefully remove the exhaust system from the bike.

S) Attach the new mounting bracket to the original silencer mounting point using the supplied hardware. Do not fully tighten yet, you will do that in a later stage.

T) If your header gaskets are in good condition you can reuse them. If they're not you should replace them now with Triumph part number T2200854. Loosely bolt the collars to the engine ports using the flanges so that the collar still has movement during installation. Ensure the holes on the outside flanges are to the bottom and the holes on the middle flange is to the top.

U) Starting from the left side fit the header pipes over the collars making sure the pipework goes inside the flange. Secure them with the spring.

V) Slide the 3 into 1 collector over the header pipes, the lambda sensor boss should be on the left side of the bike. Ensure that the headers pipes are inserted all of the way into the collector.

W) Slide the connecting pipe onto the collector.

X) Slide the Scorpion silencer onto the connecting pipe and loosely attach to the bracket with the supplied hardware.

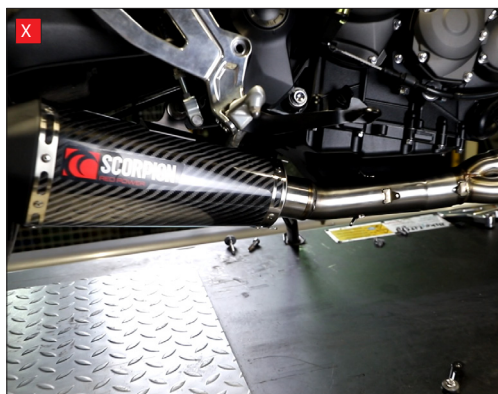
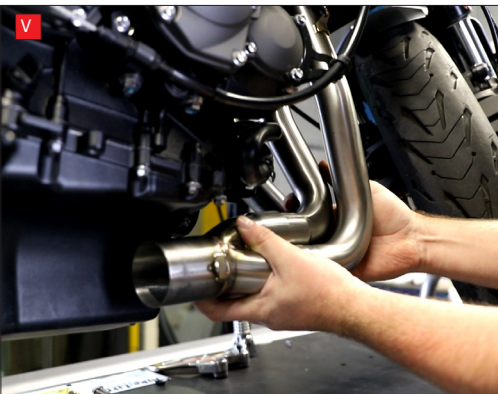
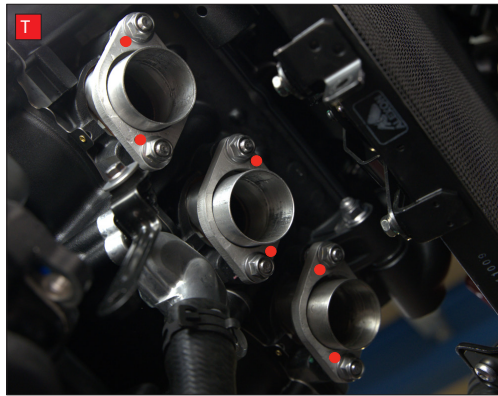
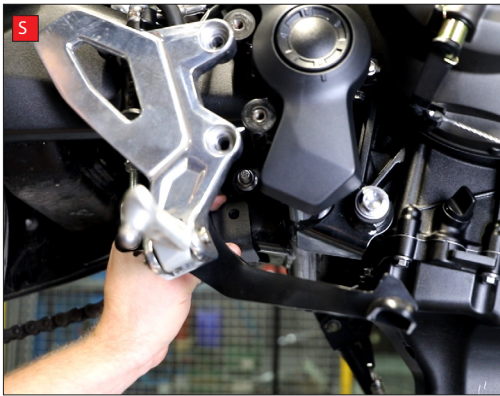

Bike	Triumph Tiger Sport 660	Part No.	RTR-93-SYS
Year	2022-Current	Fit Kits	Z039.10697
Notes	Where not supplied use original fittings If header gaskets need replacing use Triumph part number T2200854	dB Killer	SCEXDBK23 (TYPE V)

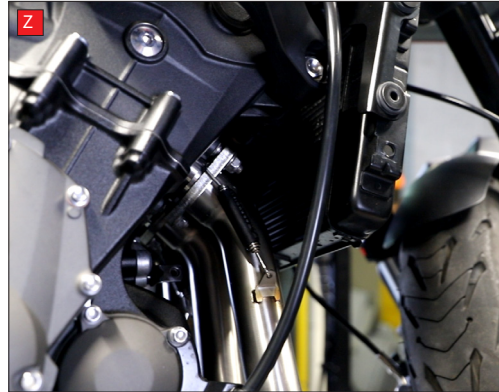

Y) Install the remaining springs between the spring hoops.

Z) Adjust the system so that it fits nicely under no stress, once again ensure that the header pipes are all of the way into the collector and then fully tighten the header nuts.

AA) Now fully tighten the 2 bolts on the rear silencer mounting bracket.

AB) Re-fit the foot rest on the right side of the bike and fully tighten the bolts.

AC) Re-fit the foot rest on the left side of the bike and fully tighten the bolts.

AD) Re-fit the radiator lower mounting bracket.

AE) Attach the right side of the radiator to the mounting bracket and fully tighten the screws.

AF) Re-fit the right side panel and fully tighten the screws.

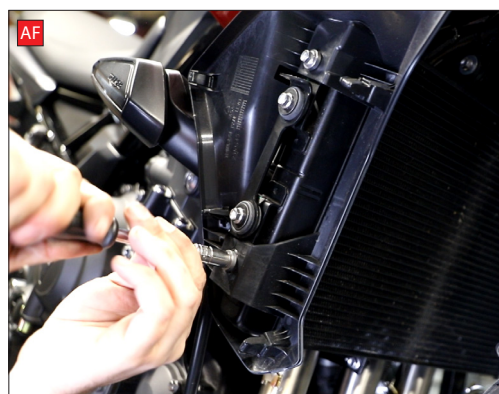
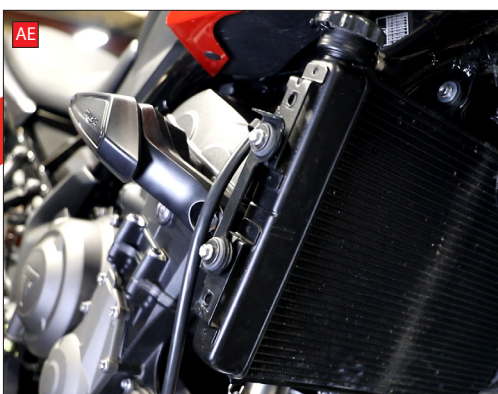
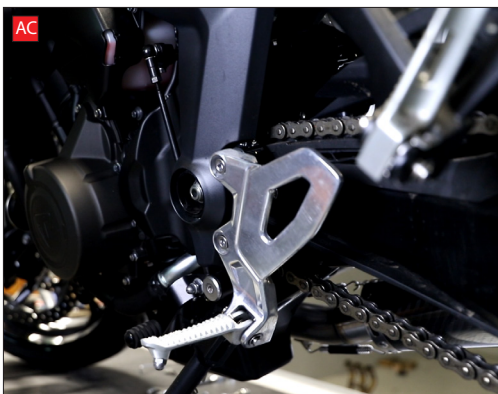
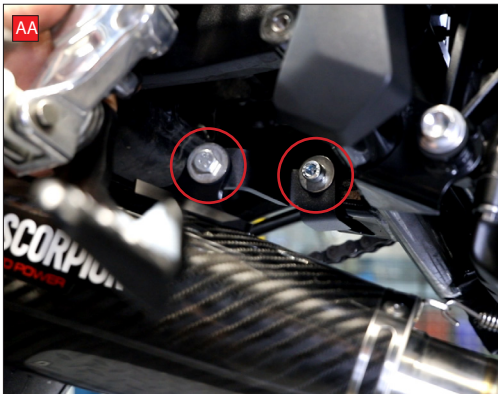

Bike	Triumph Tiger Sport 660	Part No.	RTR-93-SYS
Year	2022-Current	Fit Kits	Z039.10697
Notes	Where not supplied use original fittings If header gaskets need replacing use Triumph part number T2200854	dB Killer	SCEXDBK23 (TYPE V)



AG) Re-fit the right side cover and secure in place with the original screw.

AH) Attach the left side of the radiator to the mounting bracket and fully tighten the screws.

AI) Feed the horn wiring through the left side panel and reconnect the horn then re-fit the left side panel and fully tighten the screws.

AJ) Re-fit the left side cover and secure in place with the original screw.

AK) Fully tighten the radiator upper mounting bolt.

AL) Re-fit the lambda sensor and tighten.

AM) Run the wire in its original route above the oil filter and reconnect the plug.

AN) Re-attach the rubber cable tie.

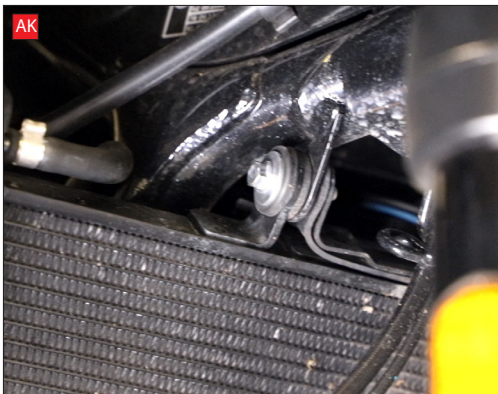

Take the bike for a short ride to ensure all functions are correct. When the bike & exhaust are cool enough check all nuts and bolts are still secure.

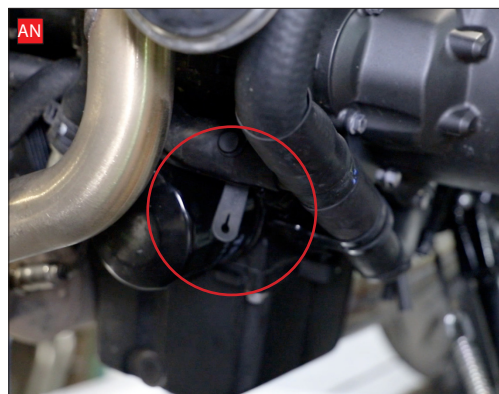

Bike	Triumph Tiger Sport 660	Part No.	RTR-93-SYS
Year	2022-Current	Fit Kit	Z039.10697
Notes	Where not supplied use original fittings If header gaskets need replacing use Triumph part number T2200854	dB Killer	Z038.10043 (TYPE V)

Estimated Fitting Time: 60 Minutes



Thank you for purchasing your Scorpion Silencer.

Care of your exhaust: Please refrain from cleaning silencer with heavy solvents or abrasives!

Vielen Dank Für den kauf eines Scorpion Schalldampfers! Pflegehinweis: Bitte verwenden Sie niemals Scheuermittel oder aggressive Reiniger zur Pflege Ihres Auspuffes!

Merci d'avoir choisi un echappement Scorpion.

Entretien de votre silencieux: Ne pas utiliser de solvants ou de produits abrasifs!

“Muchas gracias por adquirir un Silencioso Scorpion. Le recomendamos no limpiar el silencioso con productos abrasivos o aquellos que contengan disolventes.”



STAY CONNECTED TO RED POWER.