

Bike	Kawaski ZX-4RR	Part No.	RKA-146
Year	2023-current	Fit Kit	Z039.10732
Notes	Where not supplied use original fittings.	dB Killer	SCEXDBK24 (Type W)

Estimated Fitting Time: 30 Minutes

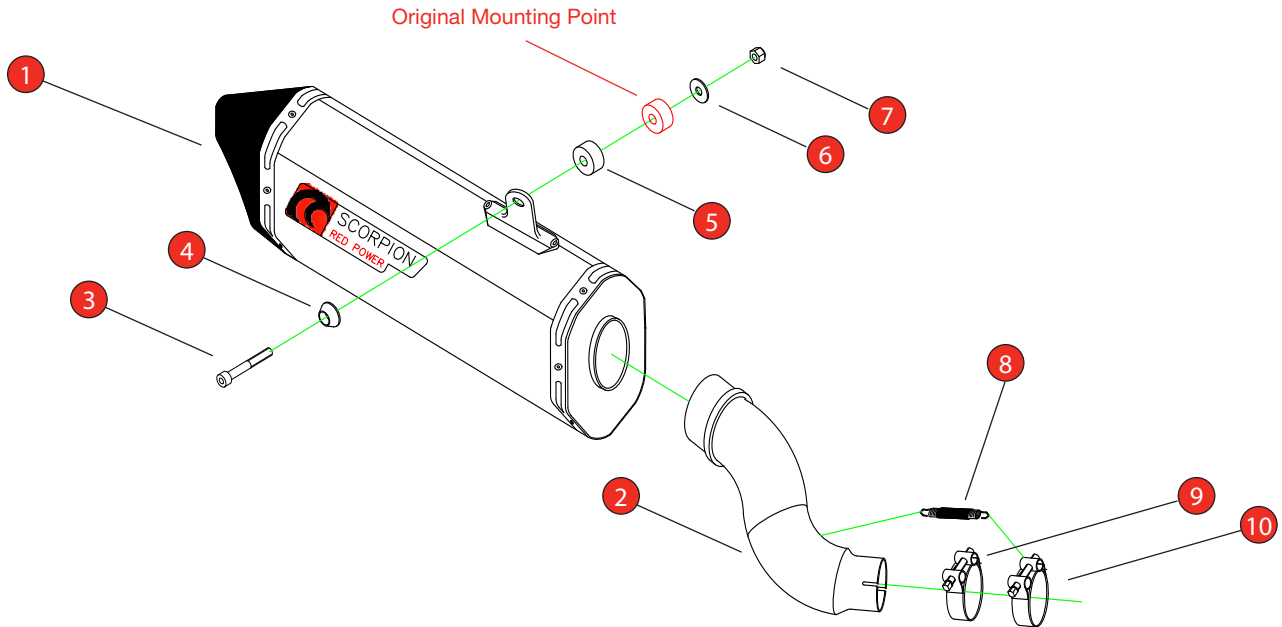

NO.	PART NO.	DESCRIPTION	QTY
1	RSC522	Serket Parallel Silencer	1
2	CP1182	Connecting Pipe	1
Fit Kit - Z039.10732			
3	Z017.10081	M8 x 65mm Cap Head Bolt	1
4	Z026.20341B	Black Anodised Alloy Bolt Finisher	1
5	Z026.20341	20mm Black Anodised Alloy Spacer	1
6	Z017.10831	M8 x 17mm Washer	1
7	Z017.10062	M8 Nyloc Nut	1
8	Z028.10030	Rubber Coated Spring	1
9	Z016.10002	51-55mm Clamp	1
10	Z028.20431	51-55mm Clamp with Spring Hoop	1

CLASSIFICATION	Closed Circuit Product
HOMOLOGATED	No
DATE	24/11/2023
ISSUE	00
AUTHORISED	S Shipley

NOTE: ENSURE SCORPION SYSTEM IS CLEAR OF MOVING PARTS AND ALL ORIGINAL FUNCTIONS WORK CORRECTLY.

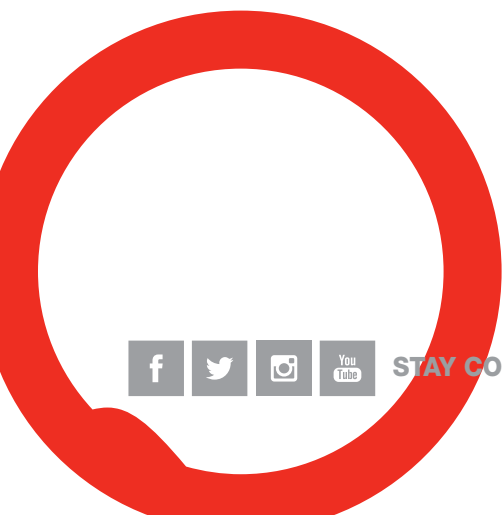

STAY CONNECTED TO RED POWER.

Bike	Kawaski ZX-4RR	Part No.	RKA-146
Year	2023-current	Fit Kits	Z039.10732
Notes	Where not supplied use original fittings.	dB Killer	SCEXDBK24 (Type W)

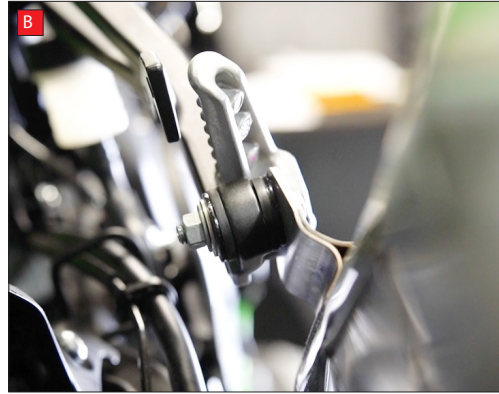

A) Loosen the clamp for the rear silencer.

B) Loosen the rear silencer mounting bolt/nut.

C) Remove the nut and washer from the back of the mount, then support the weight of the silencer and remove the mounting bolt.

D) Carefully remove the rear silencer from the bike.

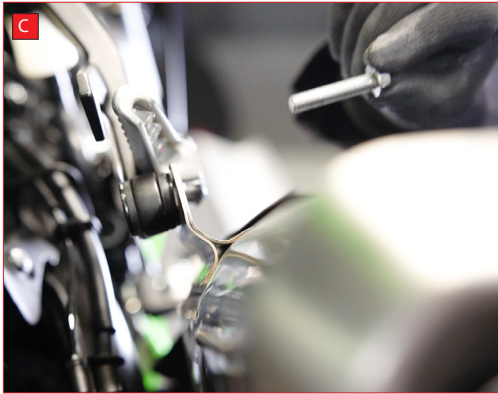

E) If the gasket stays on the original connecting pipe, remove it as it's not required when fitting the Scorpion slip-on.

F) Remove the 2 highlighted bolts from the exhaust shield then remove the shield.

G) Unscrew the supplied clamp that has the spring hoop attached to it, then slide it over the original exhaust pipe.

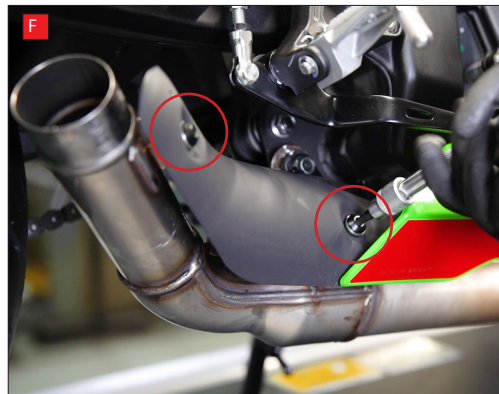

H) Align the clamp approximately 95mm from the end of the pipe then tighten up but leave a little loose to allow for adjustment later.

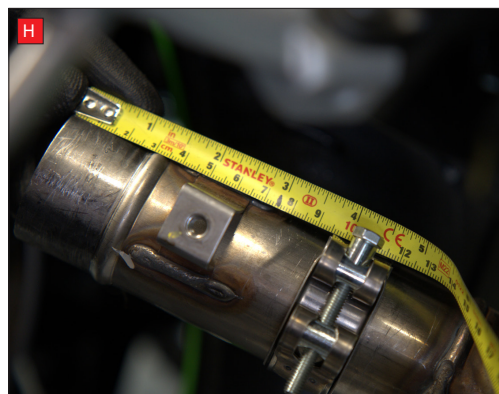

Bike	Kawaski ZX-4RR	Part No.	RKA-146
Year	2023-current	Fit Kits	Z039.10732
Notes	Where not supplied use original fittings.	dB Killer	SCEXDBK24 (Type W)



I) Place the plain clamp over the Scorpion connecting pipe then slide the pipe onto the original exhaust.

J) Slide the Scorpion silencer onto the connecting pipe.

K) Place the supplied spacer between the silencer mounting bracket and the original mounting point on the bike.

L) Put the bolt through the bolt finisher, then through the mount/ spacer then secure in place with the washer and nut.

M) Rotate the clamp with spring hoop so that it's in line with the spring hoop on the connecting pipe and tighten the clamp. Attach the spring between the hoops.

N) Fully tighten the connecting pipe clamp.

O) Fully tighten the silencer mounting hardware.

P) Re-install the exhaust shield.

Take the bike for a short ride to ensure all functions are correct. When the bike & exhaust are cool enough check all nuts and bolts are still secure.

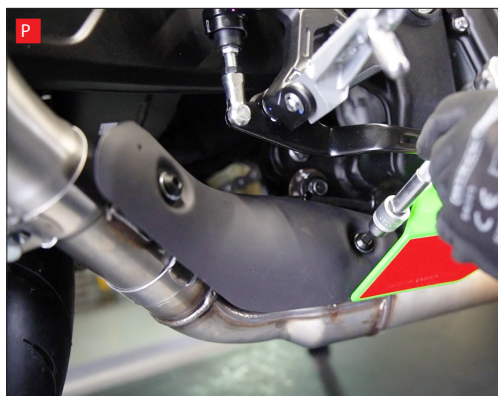
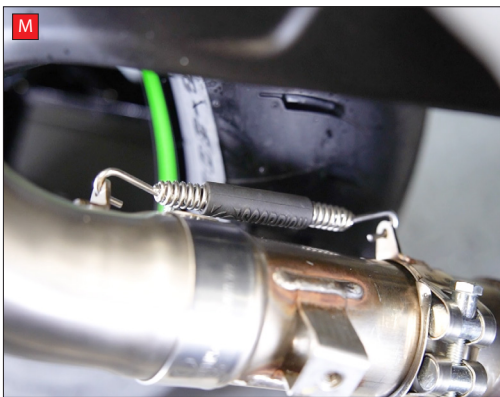
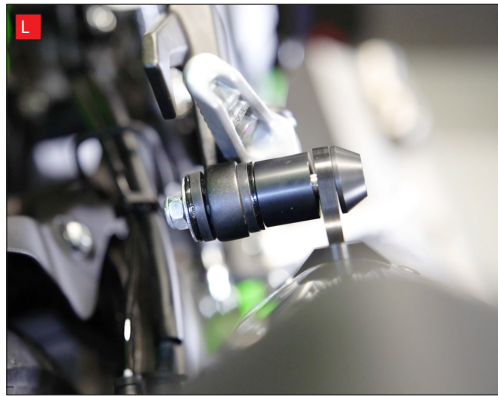
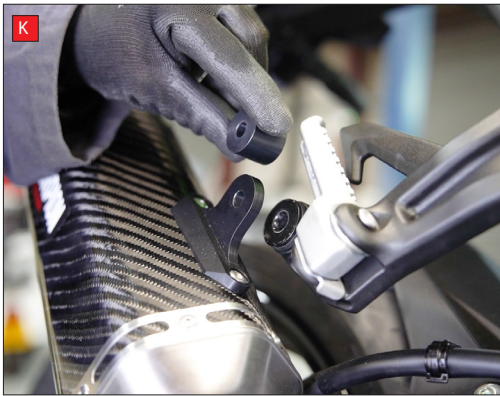

Bike	Kawaski ZX-4RR	Part No.	RKA-146
Year	2023-current	Fit Kit	Z039.10732
Notes	Where not supplied use original fittings.	dB Killer	SCEXDBK24 (Type W)

Estimated Fitting Time: 30 Minutes



Thank you for purchasing your Scorpion Silencer.

Care of your exhaust: Please refrain from cleaning silencer with heavy solvents or abrasives!

Vielen Dank Fur den kauf eines Scorpion Schalldampfers! Pflegehinweis: Bitte verwenden Sie niemals Scheuermittel oder aggressive Reiniger zur Pflege Ihres Auspuffes!

Merci d'avoir choisi un echappement Scorpion.

Entretien de votre silencieux: Ne pas utiliser de solvants ou de produits abrasifs!

Muchas gracias por adquirir un Silencioso Scorpion. Le recomendamos no limpiar el silencioso con productos abrasivos o aquellos que contengan disolventes.



STAY CONNECTED TO RED POWER.